

TST4118 - TST4118K

PORTAVALIGIE LATERALE SPECIFICO - SPECIFIC TUBULAR SIDE-CASE HOLDER - PORTE-VALISES LATÉRAUX SPÉCIFIQUE
 SPEZIFISCHES STAHLROHR-SEITENTRAEGER - PORTA MALETAS LATERALES ESPECÍFICO - TRONCO LADO ESPECÍFICO

KAWASAKI Z900 (2017)

N°	Descrizione	Caratteristiche	Codice	Quantità
1	Supporto - Support - Support Halterung - Soporte - Apoio	-	TST4118DXV TST4118SXV	2 (Dx,Sx)
2	Supporto inferiore - Lower support - Support inférieur - Soporte inferior - Untere Halterung - Soporte inferior	-	GNB1904DXV GNB1904SXV	2 (Dx,Sx)
3	Vite - Screw Vis - Schraube Tornillo - Parafuso	TBEI M6x55	655TBEI	2
4	Vite - Screw Vis - Schraube Tornillo - Parafuso	TCEI M8x30	830TCEI	2
5	Vite - Screw Vis - Schraube Tornillo - Parafuso	TCEI M6x20	620TCEI	1
6	Vite - Screw Vis - Schraube Tornillo - Parafuso	TSP M6x25	625TSP	4
7	Dado - Bolt - Ecrou Mutter - Tuerca - Porca	Dado Autobloccante Flangiato M6	6DADIABFN	2
8	Dado - Bolt - Ecrou Mutter - Tuerca - Porca	Dado Autobloccante Flangiato Ribassato M6	6DADIAFL	4
9	Funghetto - Side support - Champignon Pilz - Brida	-	Z125X	4
10	Rondella - Washer Rondelle - Scheibe Arandela - Arruela	-	6RON	2
11	Rondella - Washer Rondelle - Scheibe Arandela - Arruela	-	618RON	2
12	Dado - Bolt - Ecrou Mutter - Tuerca - Porca		V261	2
13	Particolari Inclusi Nel Kit Viteria Del 4118KIT Components Included In The Fitting Kit Of The 4118KIT Pièces Incluses Dans Le Kit De Vis De 4118KIT Die Einzelnen Teile Sind Bei Montagekit Der 4118KIT	-	-	-

TST4118 - TST4118K

PORTAVALIGIE LATERALE SPECIFICO - SPECIFIC TUBULAR SIDE-CASE HOLDER - PORTE-VALISES LATÉRAUX SPÉCIFIQUE
SPEZIFISCHES STAHLROHR-SEITENTRAEGER - PORTA MALETAS LATERALES ESPECÍFICO - TRONCO LADO ESPECÍFICO

KAWASAKI Z900 (2017)

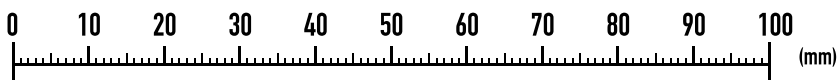
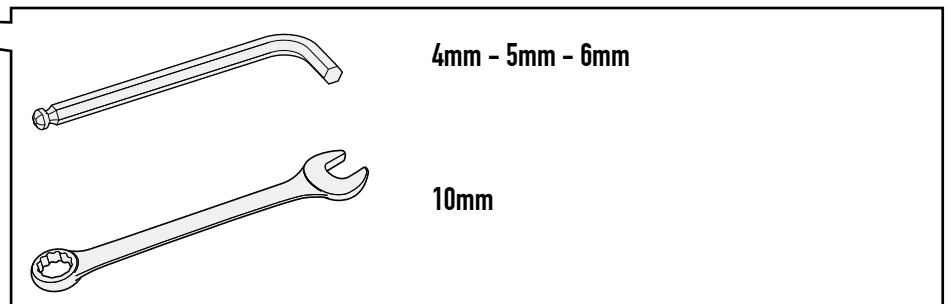
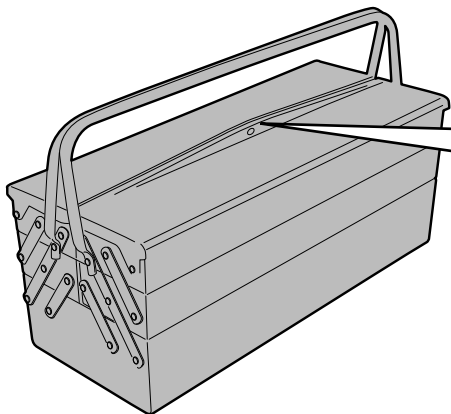
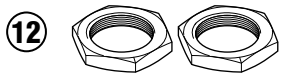
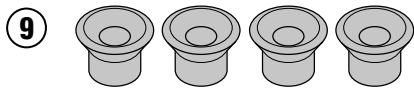
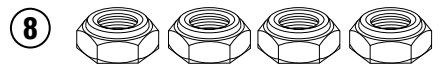
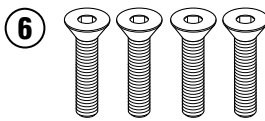
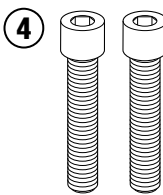
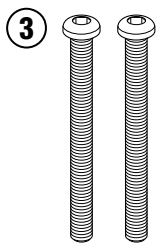
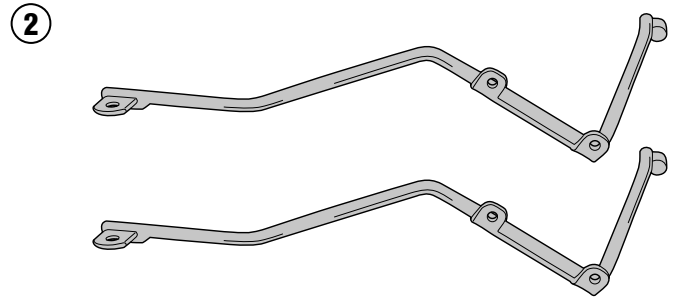
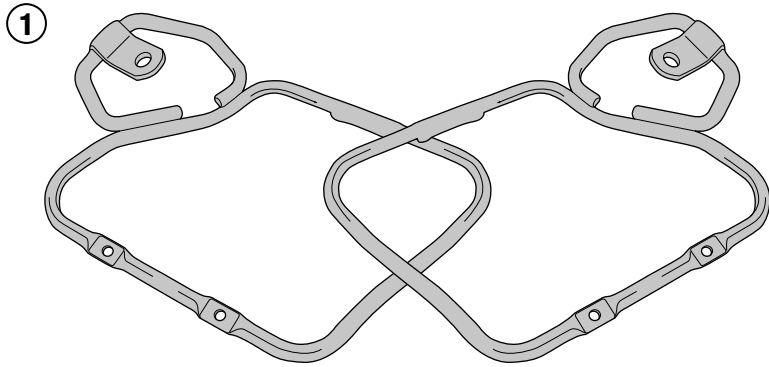

ISTRUZIONI DI MONTAGGIO - MOUNTING INSTRUCTIONS
INSTRUCTIONS DE MONTAGE - BAUANLEITUNG
INSTRUCCIONES DE MONTAJE - INSTRUÇÕES DE MONTAGEM

TST4118 - TST4118K

PORTAVALIGIE LATERALE SPECIFICO - SPECIFIC TUBULAR SIDE-CASE HOLDER - PORTE-VALISES LATÉRAUX SPÉCIFIQUE
SPEZIFISCHES STAHLROHR-SEITENTRAEGER - PORTA MALETAS LATERALES ESPECÍFICO - TRONCO LADO ESPECÍFICO

KAWASAKI Z900 (2017)

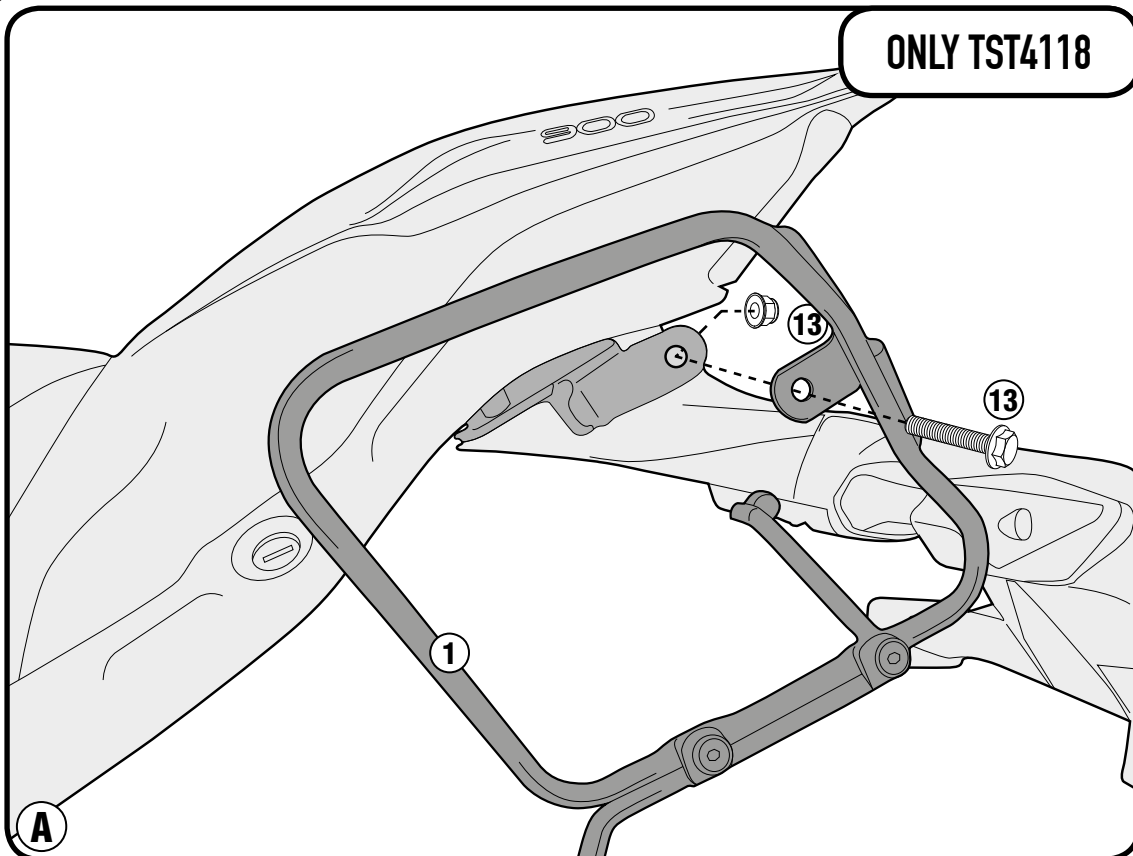
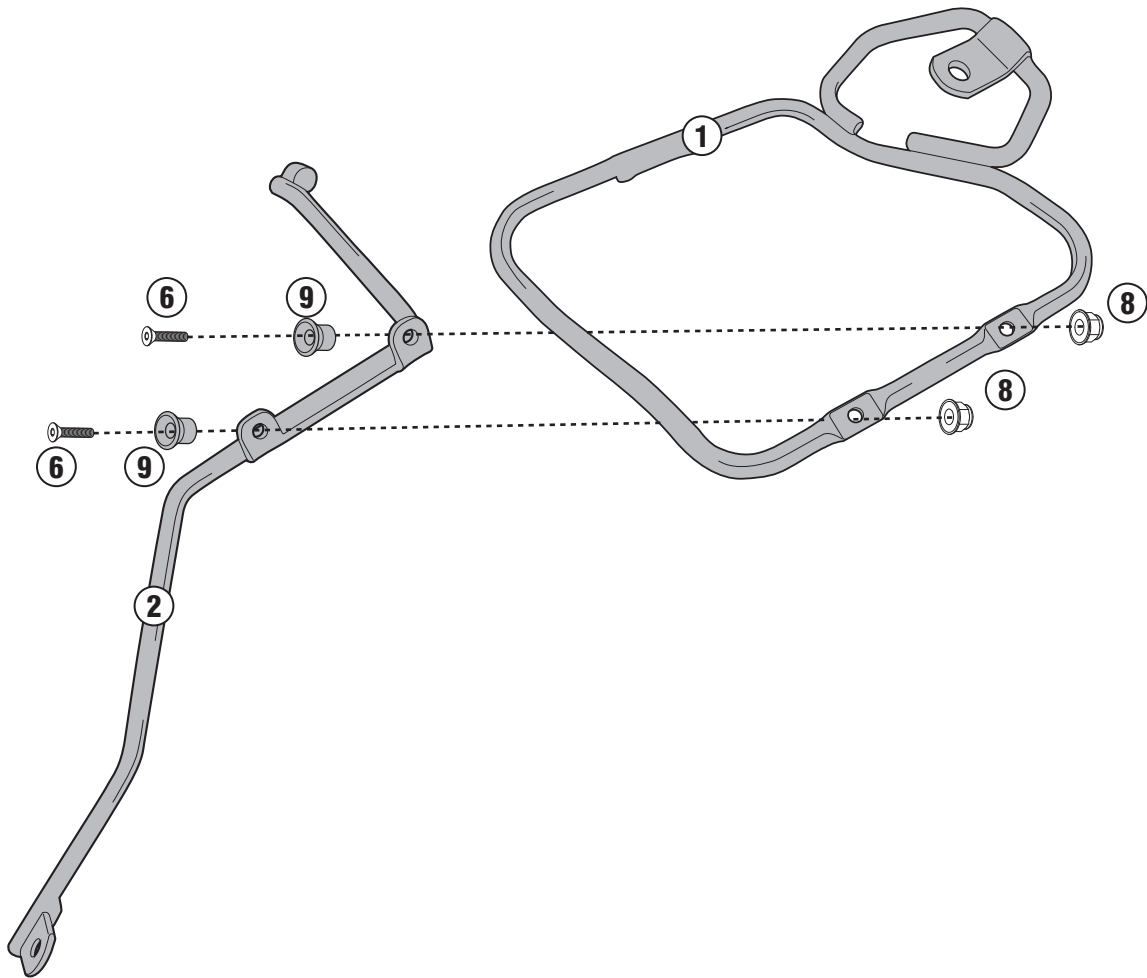

TST4118 - TST4118K

PORTAVALIGIE LATERALE SPECIFICO - SPECIFIC TUBULAR SIDE-CASE HOLDER - PORTE-VALISES LATÉRAUX SPÉCIFIQUE
SPEZIFISCHES STAHLROHR-SEITENTRAEGER - PORTA MALETAS LATERALES ESPECÍFICO - TRONCO LADO ESPECÍFICO

KAWASAKI Z900 (2017)

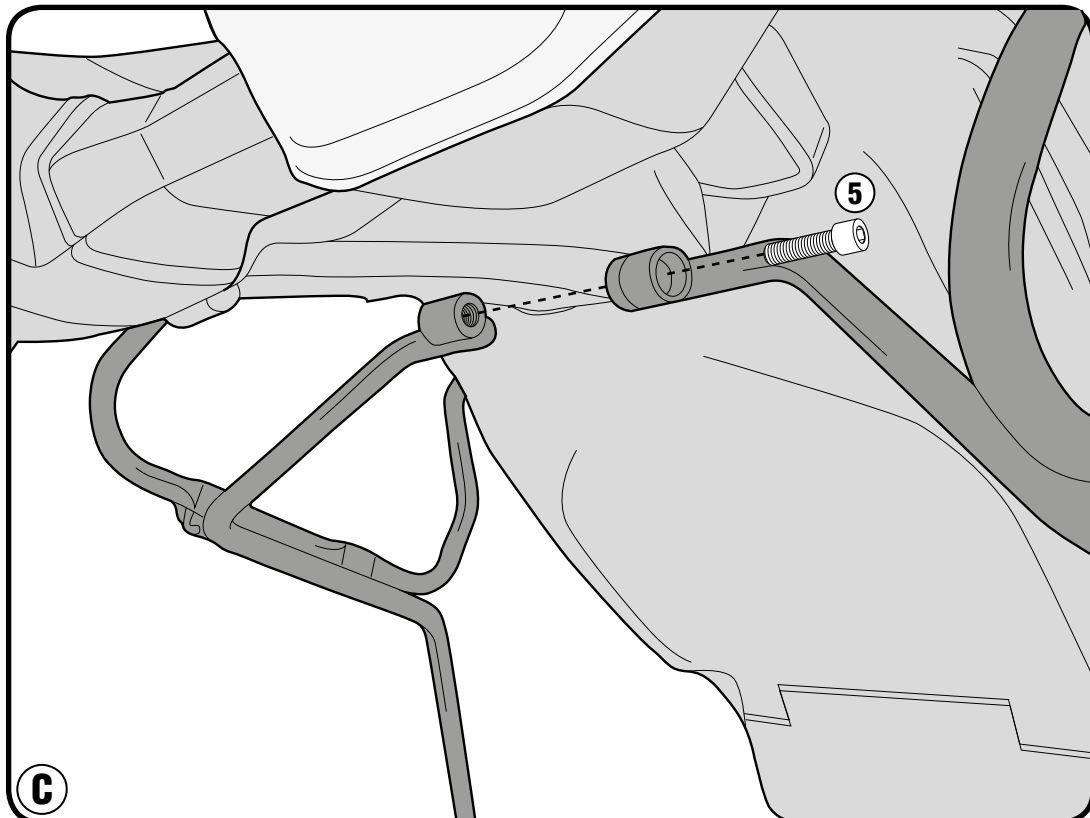
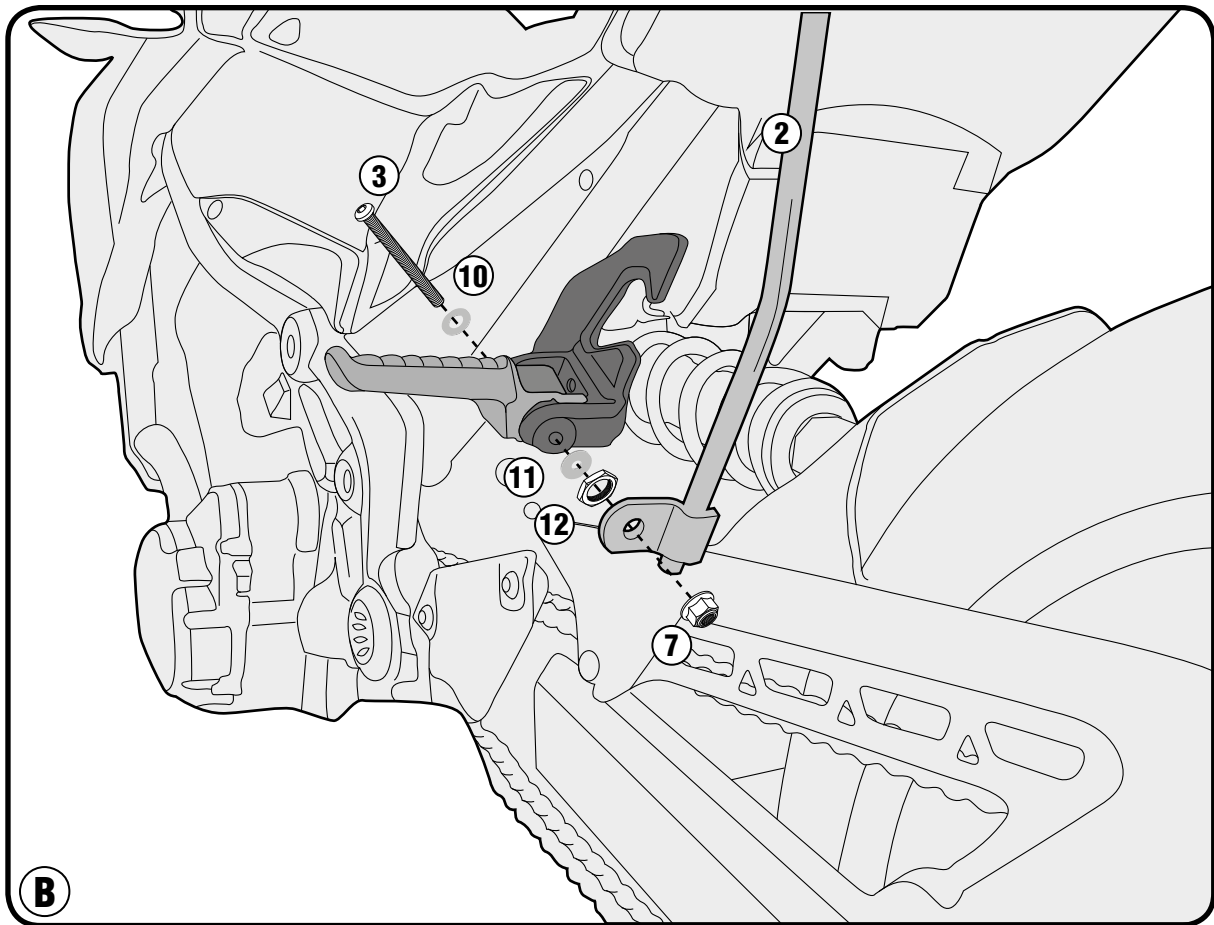

TST4118 - TST4118K

PORTAVALIGIE LATERALE SPECIFICO - SPECIFIC TUBULAR SIDE-CASE HOLDER - PORTE-VALISES LATÉRAUX SPÉCIFIQUE
SPEZIFISCHES STAHLROHR-SEITENTRAEGER - PORTA MALETAS LATERALES ESPECÍFICO - TRONCO LADO ESPECÍFICO

KAWASAKI Z900 (2017)

